

ELEVATION

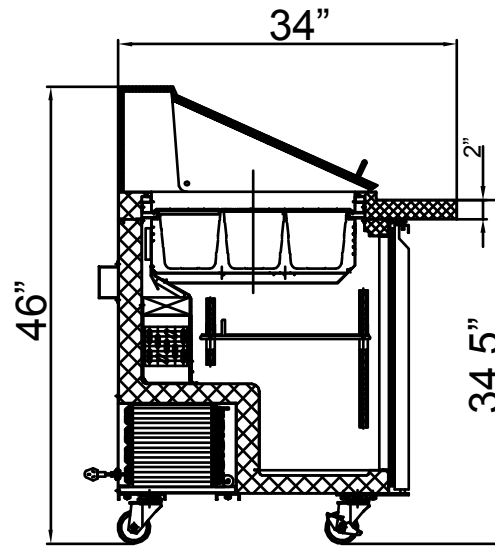

SECTION VIEW

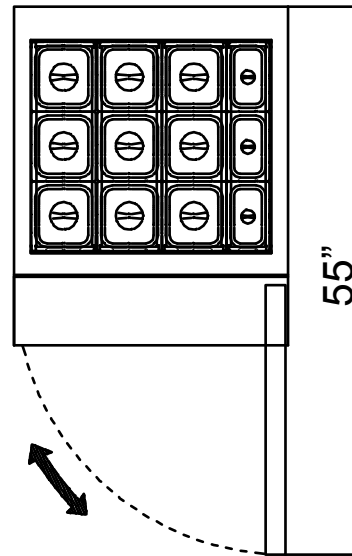

PLAN

SCLM1

Model	Compressor:HP	Refrigerant	Thermostat model	Voltage Supply	Capacity	Temperature Range	Exterior Dimensions
SCLM1		R134a	Digital Type	110V/60Hz/1PHASE	160L	0°~10°C	27.5" X 34" X 46"