

II  
1:2

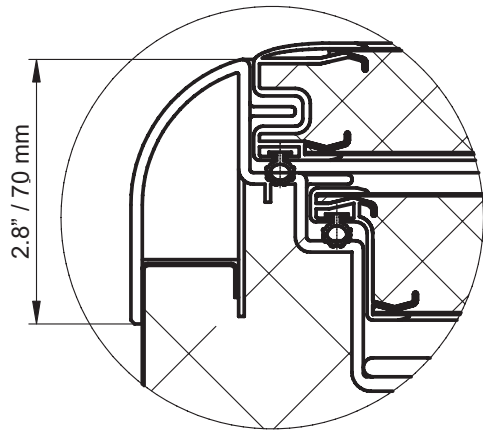

I  
1:2

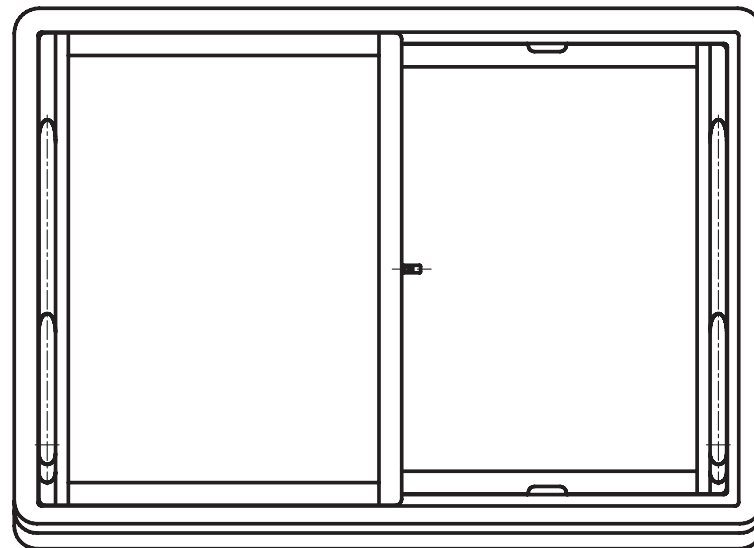
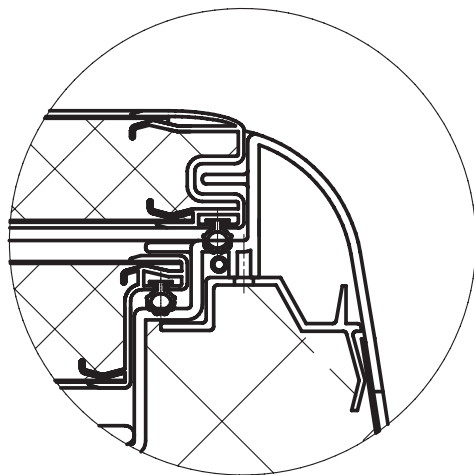

**ITEM 46492**