

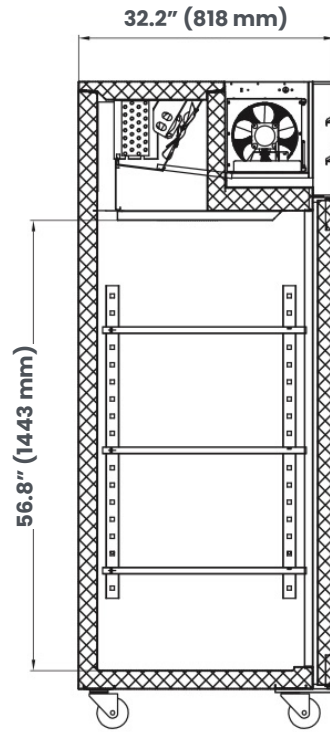

SERVING THE FOOD INDUSTRY SINCE 1951

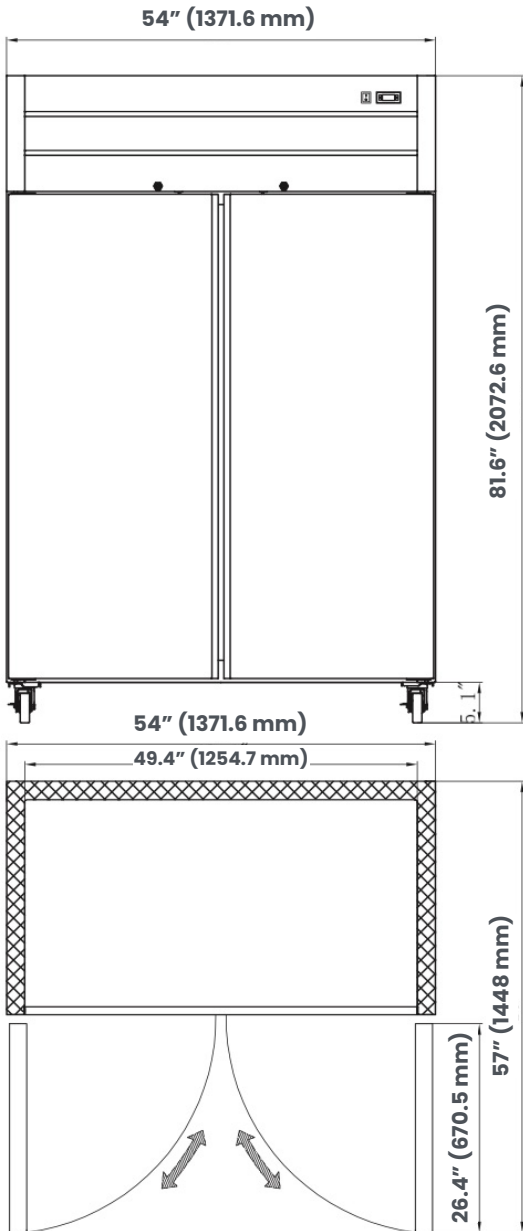

ITEM: 50117

